

# TYP M25/M40 MODELL CK

BIG-BAG-Entladestationen



Pendelbecherwerke



Förderbänder



Hub- und Kippgeräte



**HUMBERT & POL**  
FÖRDERANLAGEN – CONVEYING SYSTEMS

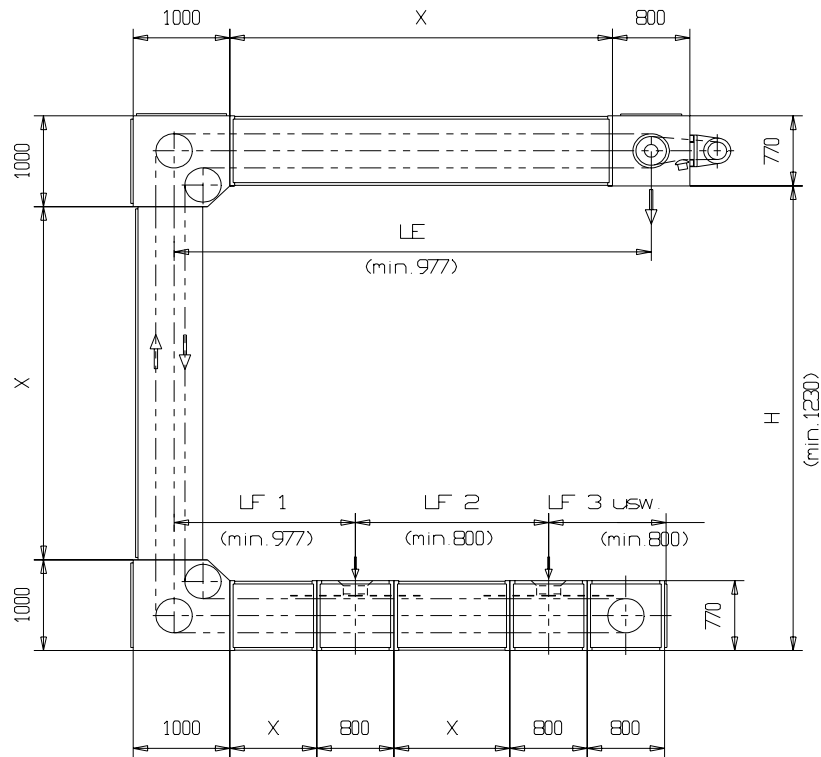

Draufsicht Fullstation

Anschlußflansch  
Abgabestation

Typ	M25	M40
A	250	450
B	700	950

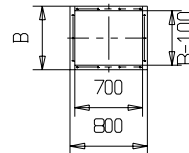
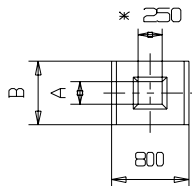

X = Schächte in Paß- und Normlänge (1550 mm)  
\* = variables Maß

# TYP M25/M40 MODELL CA

BIG-BAG-Entladestationen



Pendelbecherwerke



Förderbänder



Hub- und Kippgeräte



**HUMBERT & POL**  
FÖRDERANLAGEN – CONVEYING SYSTEMS

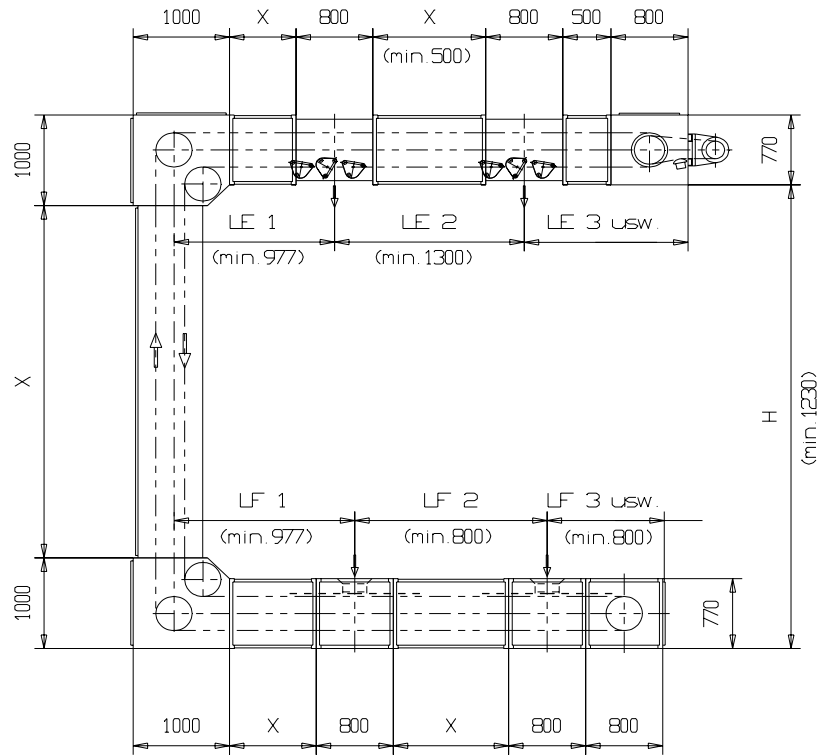

Draufsicht Füllstation

Anschlußflansch  
Abgabestation

Typ	M25	M40
A	250	450
B	700	950

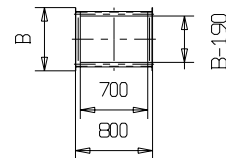
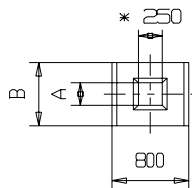

X = Schächte in Paß- und Normlänge (1550 mm)  
\* = variables Maß

# TYP M25/M40 MODELL ZK

BIG-BAG-Entladestationen



Pendelbecherwerke



Förderbänder



Hub- und Kippgeräte



## HUMBERT & POL

FÖRDERANLAGEN – CONVEYING SYSTEMS

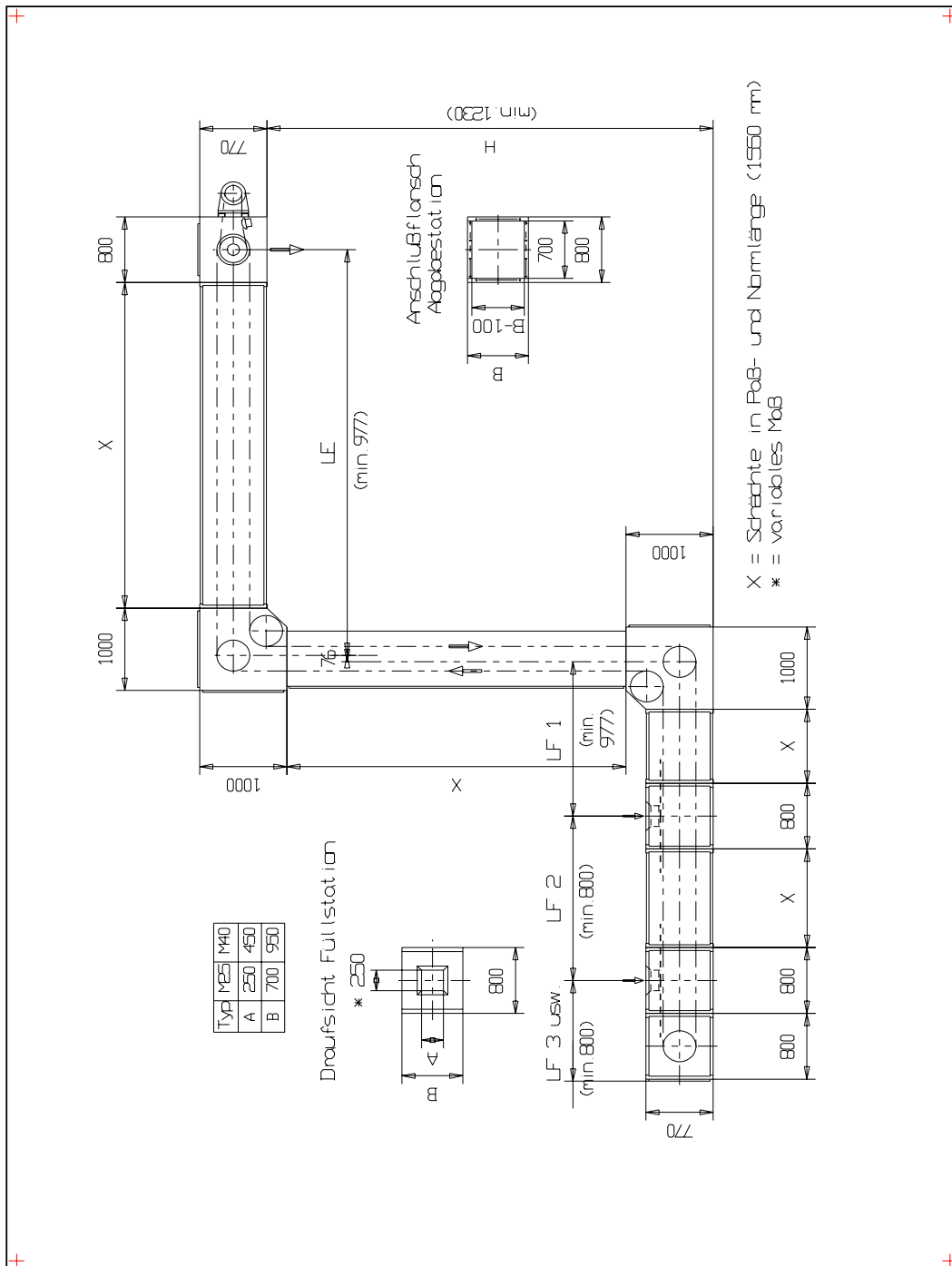

# TYP M25/M40 MODELL ZA

BIG-BAG-Entladestationen



Pendelbecherwerke



Förderbänder



Hub- und Kippgeräte



## HUMBERT & POL

FÖRDERANLAGEN – CONVEYING SYSTEMS

